

- NOTES:**
1. DRAIN TILE MAY BE ELIMINATED AT THE DISCRETION OF THE SITE ENGINEER.
 2. DAYLIGHT DRAIN TILE AT LOW POINTS THROUGH WALL FACE OR AT ENDS; MAXIMUM SPACING 100 FEET OR PER SITE CONDITIONS.

GRAVITY WALL CROSS SECTION
NOT TO SCALE

DISCLAIMER:
These typical details are preliminary and conceptual in nature. They are provided for general information purposes only. Anyone making use of these details and related information does so at their own risk and assumes all liability for such use. Site specific design should be performed by a licensed Professional Engineer based on actual site conditions, materials, and local practices.

Stone Strong LLC retains all common law, statutory, and other reserved rights to these drawings including the copyright. Limited license is granted to copy, reproduce, or modify the details to prepare construction drawings for Stone Strong retaining walls. Stone Strong LLC makes no warranties, either expressed or implied, of merchantability or fitness for any particular purpose, and accepts no responsibility for the accuracy, suitability, or completeness of information contained herein.



STONE STRONG SYSTEMS®
www.stonestrong.com

PROJECT	
CROSS SECTIONS STONE STRONG SYSTEMS	
DATE: 6/29/18	FILE: 01_24sf.XSec.Grav

NOTE:
 IN SOME CASES, TWO 24-62 OR 24-86
 UNITS MAY BE REQUIRED FOR INTERNAL
 STABILITY.

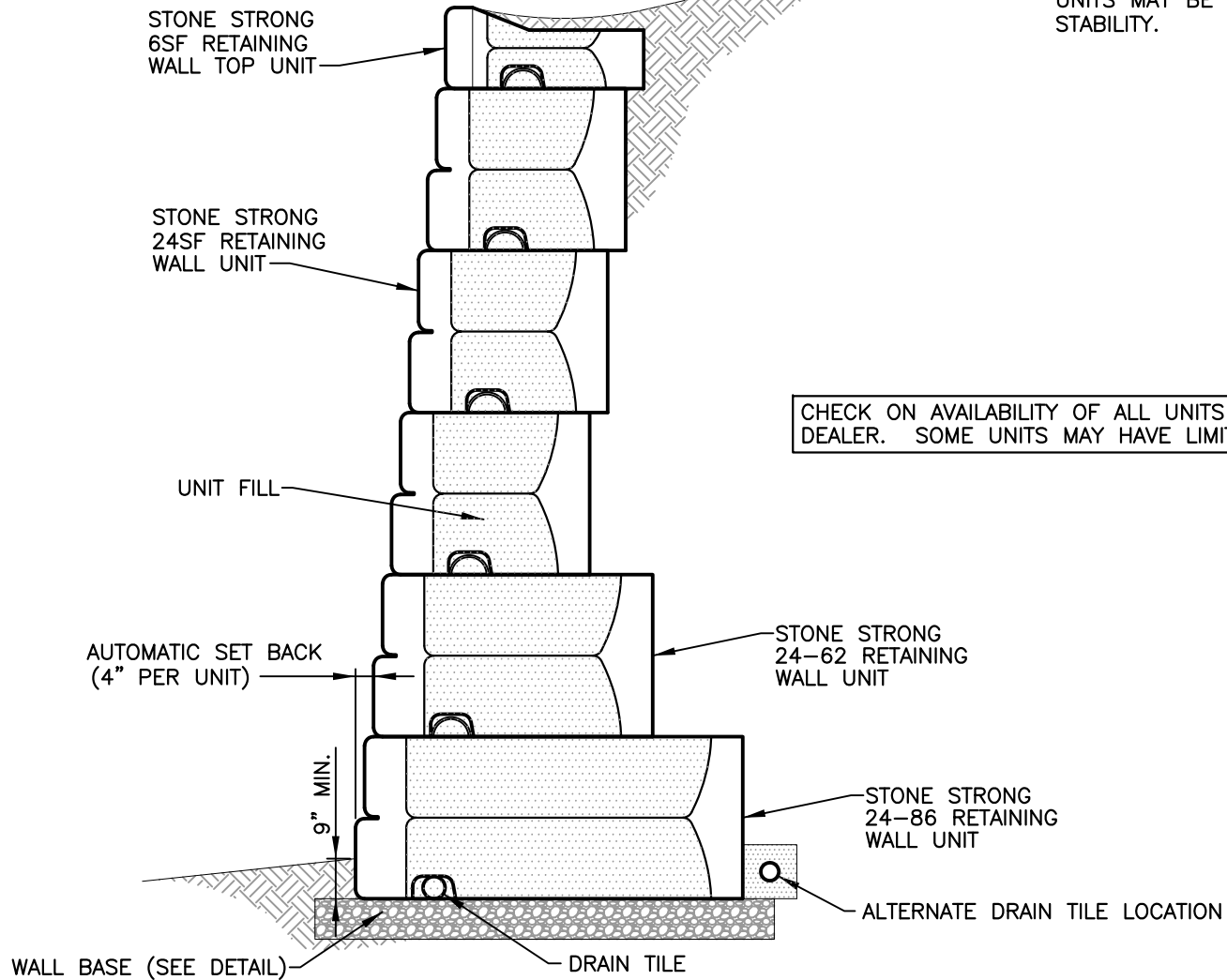

CHECK ON AVAILABILITY OF ALL UNITS w/ LOCAL PRODUCER/
 DEALER. SOME UNITS MAY HAVE LIMITED AVAILABILITY.

GRAVITY WALL CROSS SECTION w/EXTENDED BASE UNITS

NOT TO SCALE

DISCLAIMER:

These typical details are preliminary and conceptual in nature. They are provided for general information purposes only. Anyone making use of these details and related information does so at their own risk and assumes all liability for such use. Site specific design should be performed by a licensed Professional Engineer based on actual site conditions, materials, and local practices.

Stone Strong LLC retains all common law, statutory, and other reserved rights to these drawings including the copyright. Limited license is granted to copy, reproduce, or modify the details to prepare construction drawings for Stone Strong retaining walls. Stone Strong LLC makes no warranties, either expressed or implied, of merchantability or fitness for any particular purpose, and accepts no responsibility for the accuracy, suitability, or completeness of information contained herein.

 www.stonestrong.com	PROJECT
	CROSS SECTIONS STONE STRONG SYSTEMS
DATE: 6/29/18	FILE: 02_HD XSec

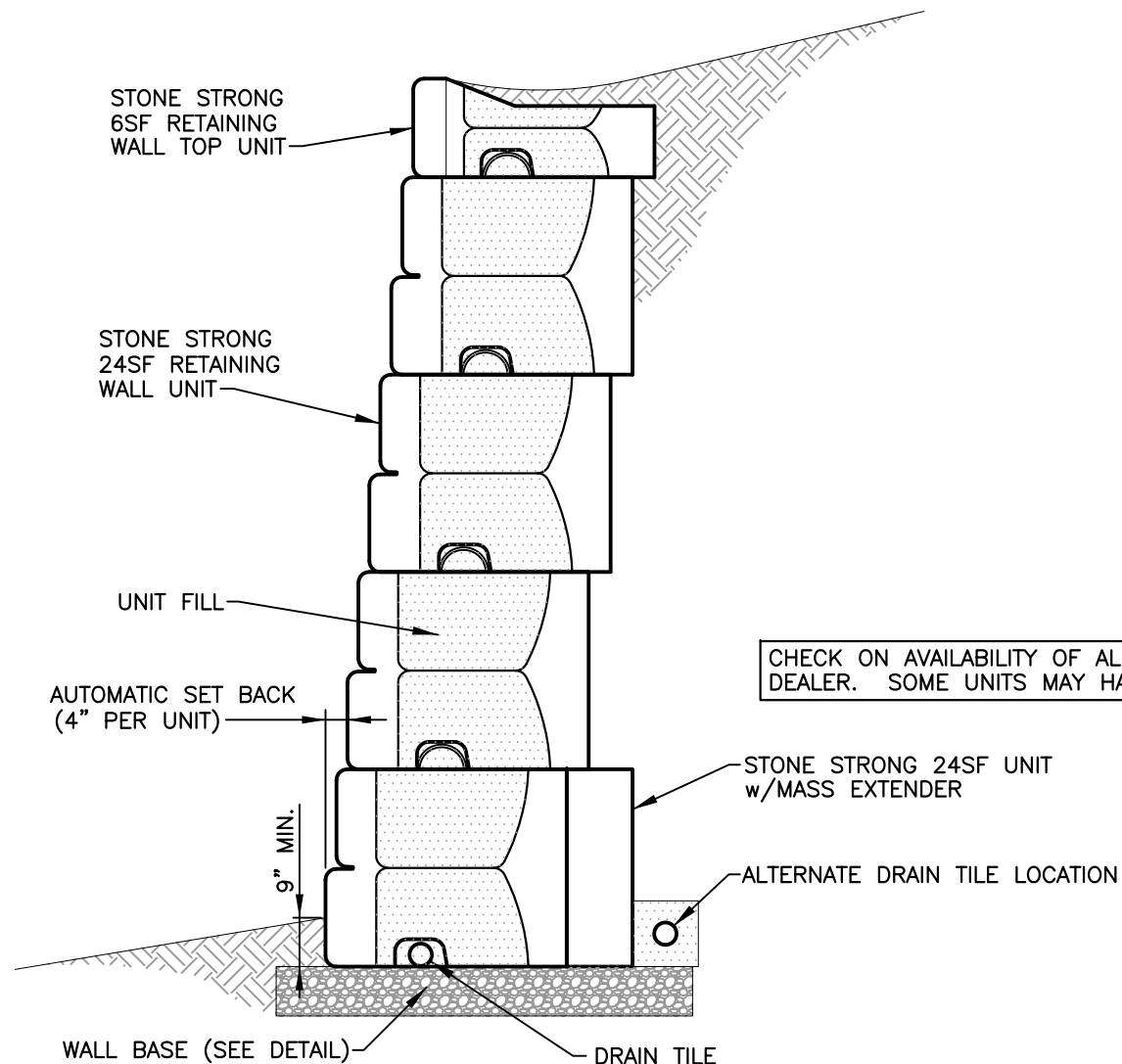

CHECK ON AVAILABILITY OF ALL UNITS w/ LOCAL PRODUCER/ DEALER. SOME UNITS MAY HAVE LIMITED AVAILABILITY.

GRAVITY WALL
CROSS SECTION w/MASS EXTENDER
 NOT TO SCALE

DISCLAIMER:

These typical details are preliminary and conceptual in nature. They are provided for general information purposes only. Anyone making use of these details and related information does so at their own risk and assumes all liability for such use. Site specific design should be performed by a licensed Professional Engineer based on actual site conditions, materials, and local practices.

Stone Strong LLC retains all common law, statutory, and other reserved rights to these drawings including the copyright. Limited license is granted to copy, reproduce, or modify the details to prepare construction drawings for Stone Strong retaining walls. Stone Strong LLC makes no warranties, either expressed or implied, of merchantability or fitness for any particular purpose, and accepts no responsibility for the accuracy, suitability, or completeness of information contained herein.

 www.stonestrong.com	PROJECT
	CROSS SECTIONS STONE STRONG SYSTEMS
DATE: 6/29/18	FILE: 03_24sf.XSec.Mass

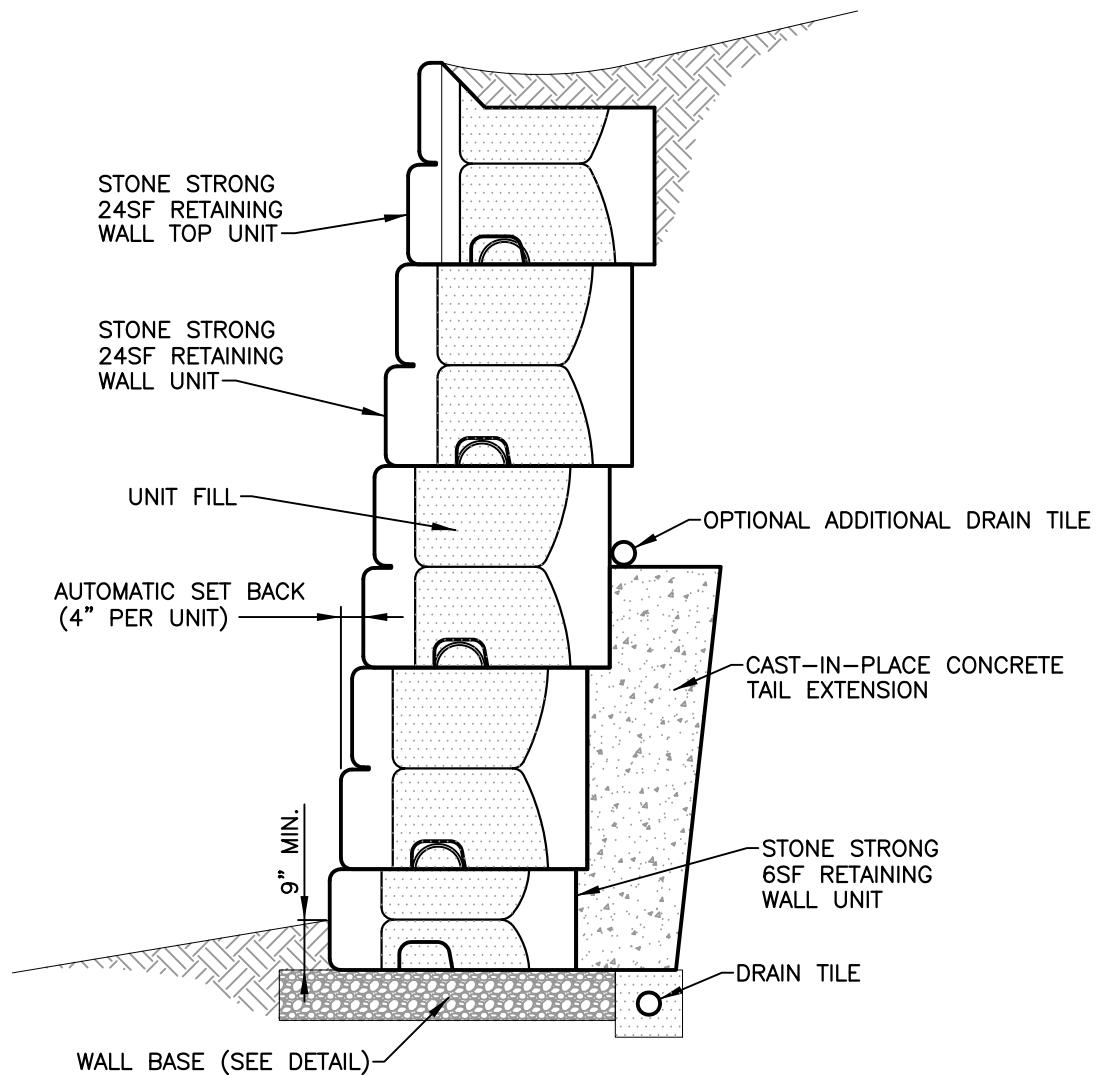

GRAVITY WALL
CROSS SECTION w/CONCRETE TAIL EXTENSION
 NOT TO SCALE

DISCLAIMER:

These typical details are preliminary and conceptual in nature. They are provided for general information purposes only. Anyone making use of these details and related information does so at their own risk and assumes all liability for such use. Site specific design should be performed by a licensed Professional Engineer based on actual site conditions, materials, and local practices.

Stone Strong LLC retains all common law, statutory, and other reserved rights to these drawings including the copyright. Limited license is granted to copy, reproduce, or modify the details to prepare construction drawings for Stone Strong retaining walls. Stone Strong LLC makes no warranties, either expressed or implied, of merchantability or fitness for any particular purpose, and accepts no responsibility for the accuracy, suitability, or completeness of information contained herein.

 www.stonestrong.com	PROJECT CROSS SECTIONS STONE STRONG SYSTEMS
	DATE: 6/29/18 FILE: 04_24sf.XSec.CIP

NOTE:
 USER SHOULD DETERMINE
 CAPABILITY OR SUITABILITY OF
 PARAPET FOR BARRIER LOADING

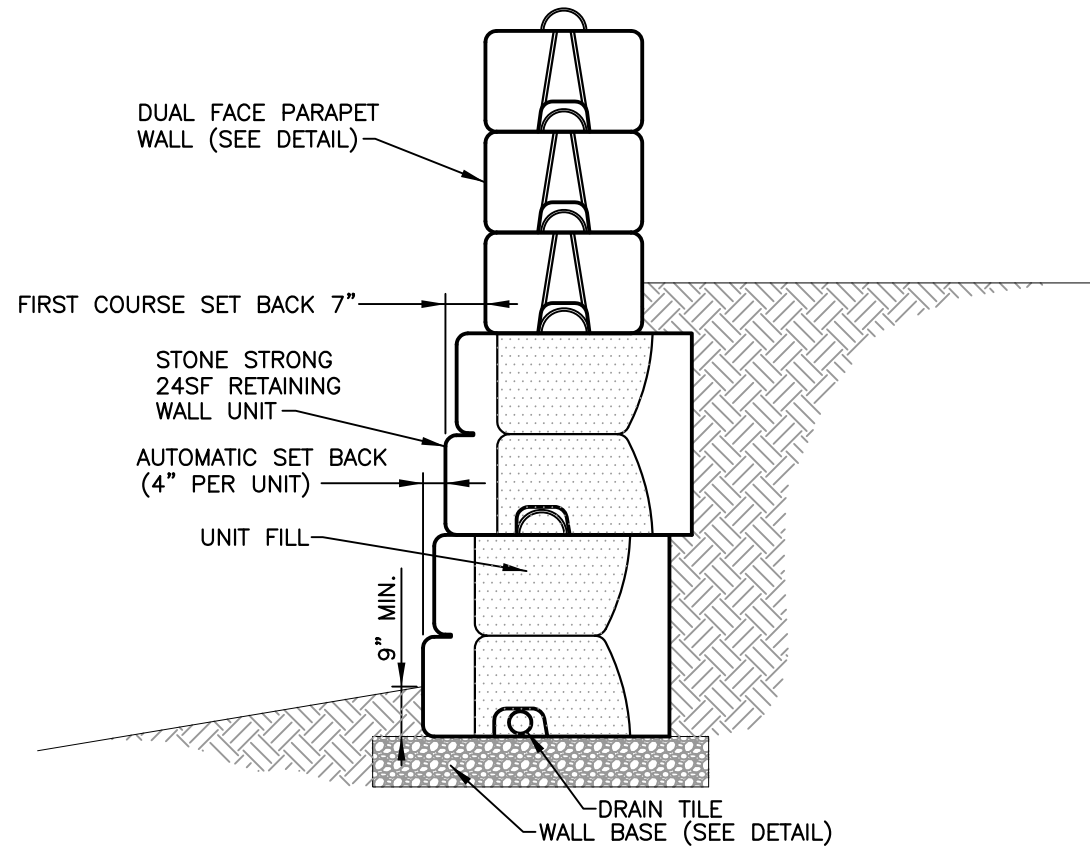

GRAVITY WALL CROSS SECTION w/ DUAL FACE PARAPET WALL

NOT TO SCALE

CHECK ON AVAILABILITY OF ALL UNITS w/ LOCAL PRODUCER/
 DEALER. SOME UNITS MAY HAVE LIMITED AVAILABILITY.

DISCLAIMER:

These typical details are preliminary and conceptual in nature. They are provided for general information purposes only. Anyone making use of these details and related information does so at their own risk and assumes all liability for such use. Site specific design should be performed by a licensed Professional Engineer based on actual site conditions, materials, and local practices.

Stone Strong LLC retains all common law, statutory, and other reserved rights to these drawings including the copyright. Limited license is granted to copy, reproduce, or modify the details to prepare construction drawings for Stone Strong retaining walls. Stone Strong LLC makes no warranties, either expressed or implied, of merchantability or fitness for any particular purpose, and accepts no responsibility for the accuracy, suitability, or completeness of information contained herein.



www.stonestrong.com

PROJECT

CROSS SECTIONS
 STONE STRONG SYSTEMS

DATE: 6/29/18

FILE: 05_24sf.XSec.Parapet

NOTES:

1. DRAIN TILE MAY BE ELIMINATED AT THE DISCRETION OF THE SITE ENGINEER.
2. DAYLIGHT DRAIN TILE AT LOW POINTS THROUGH WALL FACE OR AT ENDS; MAXIMUM SPACING 100 FEET OR PER SITE CONDITIONS.

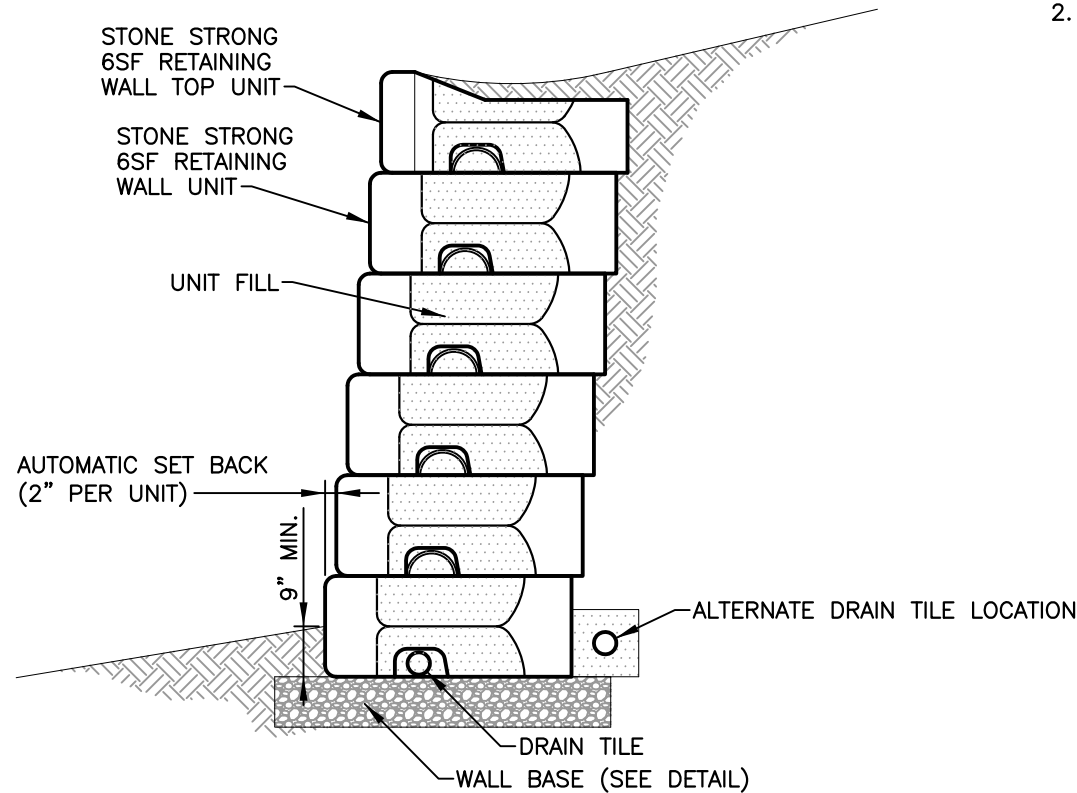

GRAVITY WALL CROSS SECTION

NOT TO SCALE

DISCLAIMER:

These typical details are preliminary and conceptual in nature. They are provided for general information purposes only. Anyone making use of these details and related information does so at their own risk and assumes all liability for such use. Site specific design should be performed by a licensed Professional Engineer based on actual site conditions, materials, and local practices.

Stone Strong LLC retains all common law, statutory, and other reserved rights to these drawings including the copyright. Limited license is granted to copy, reproduce, or modify the details to prepare construction drawings for Stone Strong retaining walls. Stone Strong LLC makes no warranties, either expressed or implied, of merchantability or fitness for any particular purpose, and accepts no responsibility for the accuracy, suitability, or completeness of information contained herein.



www.stonestrong.com

PROJECT

CROSS SECTIONS
STONE STRONG SYSTEMS

DATE: 6/29/18

FILE: 06_6sf.XSec.Grav

NOTES:

1. DRAIN TILE MAY BE ELIMINATED AT THE DISCRETION OF THE SITE ENGINEER.
2. DAYLIGHT DRAIN TILE AT LOW POINTS THROUGH WALL FACE OR AT ENDS; MAXIMUM SPACING 100 FEET OR PER SITE CONDITIONS.

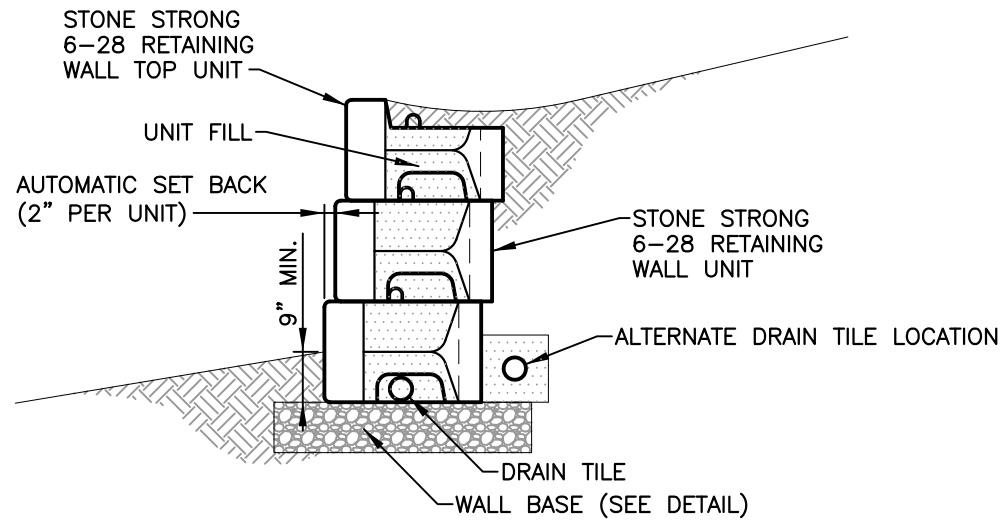

6-28 GRAVITY WALL CROSS SECTION

NOT TO SCALE

CHECK ON AVAILABILITY OF ALL UNITS w/ LOCAL PRODUCER/ DEALER. SOME UNITS MAY HAVE LIMITED AVAILABILITY.

DISCLAIMER:

These typical details are preliminary and conceptual in nature. They are provided for general information purposes only. Anyone making use of these details and related information does so at their own risk and assumes all liability for such use. Site specific design should be performed by a licensed Professional Engineer based on actual site conditions, materials, and local practices.

Stone Strong LLC retains all common law, statutory, and other reserved rights to these drawings including the copyright. Limited license is granted to copy, reproduce, or modify the details to prepare construction drawings for Stone Strong retaining walls. Stone Strong LLC makes no warranties, either expressed or implied, of merchantability or fitness for any particular purpose, and accepts no responsibility for the accuracy, suitability, or completeness of information contained herein.



www.stonestrong.com

PROJECT

CROSS SECTIONS
STONE STRONG SYSTEMS

DATE: 6/29/18

FILE: 07_6-28.XSec.Grav.Batt

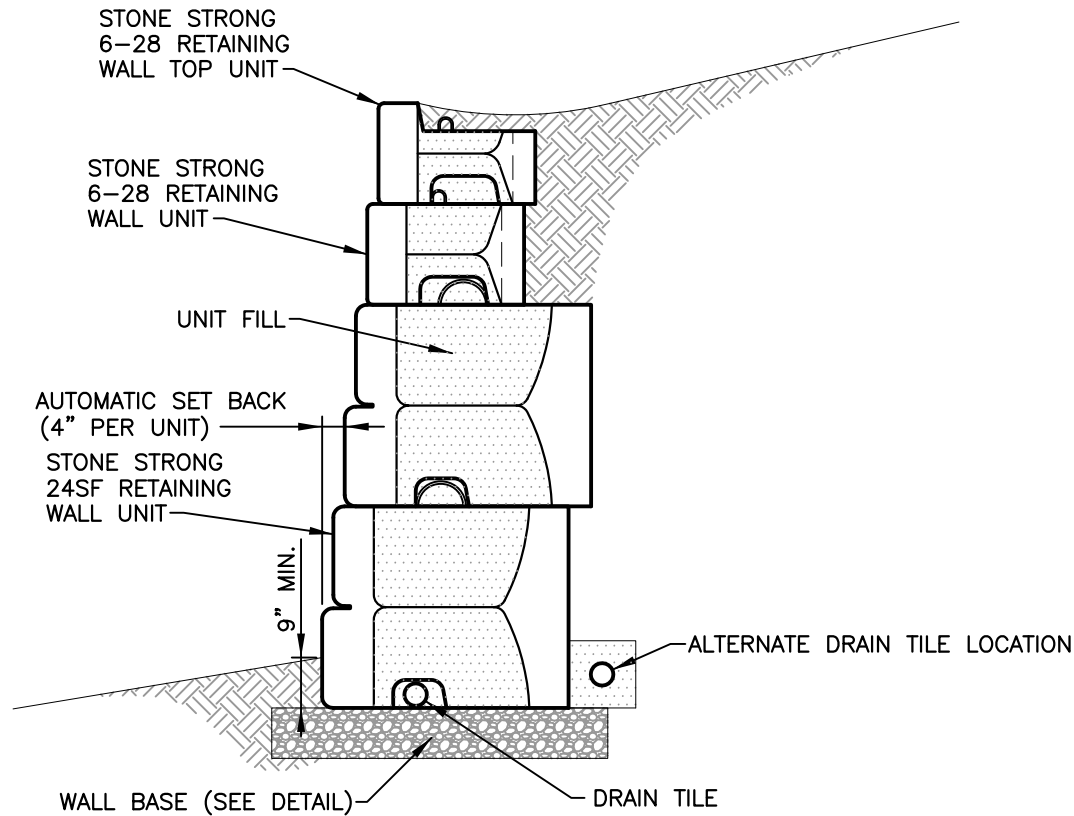

GRAVITY WALL CROSS SECTION

NOT TO SCALE

NOTES:

1. DRAIN TILE MAY BE ELIMINATED AT THE DISCRETION OF THE SITE ENGINEER.
2. DAYLIGHT DRAIN TILE AT LOW POINTS THROUGH WALL FACE OR AT ENDS; MAXIMUM SPACING 100 FEET OR PER SITE CONDITIONS.

CHECK ON AVAILABILITY OF ALL UNITS w/ LOCAL PRODUCER/ DEALER. SOME UNITS MAY HAVE LIMITED AVAILABILITY.

DISCLAIMER:

These typical details are preliminary and conceptual in nature. They are provided for general information purposes only. Anyone making use of these details and related information does so at their own risk and assumes all liability for such use. Site specific design should be performed by a licensed Professional Engineer based on actual site conditions, materials, and local practices.

Stone Strong LLC retains all common law, statutory, and other reserved rights to these drawings including the copyright. Limited license is granted to copy, reproduce, or modify the details to prepare construction drawings for Stone Strong retaining walls. Stone Strong LLC makes no warranties, either expressed or implied, of merchantability or fitness for any particular purpose, and accepts no responsibility for the accuracy, suitability, or completeness of information contained herein.



www.stonestrong.com

PROJECT

CROSS SECTIONS
STONE STRONG SYSTEMS

DATE: 6/29/18

FILE: 08_24sf.XSec.Grav.28

NOTES:

1. DRAIN TILE MAY BE ELIMINATED AT THE DISCRETION OF THE SITE ENGINEER.
2. DAYLIGHT DRAIN TILE AT LOW POINTS THROUGH WALL FACE OR AT ENDS; MAXIMUM SPACING 100 FEET OR PER SITE CONDITIONS.

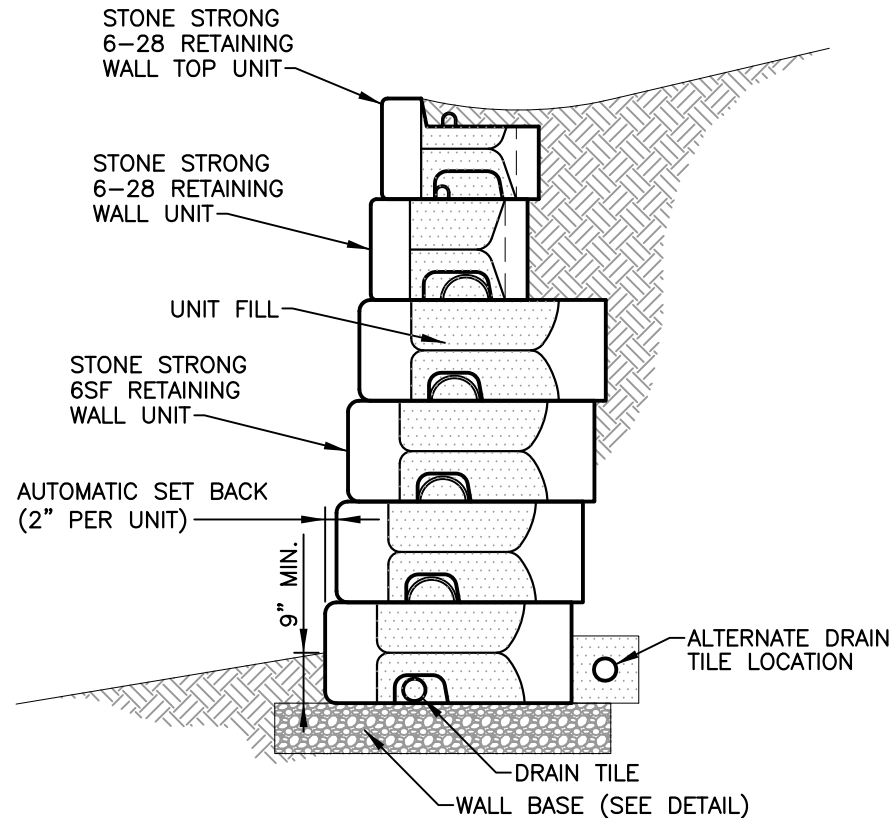

6SF GRAVITY WALL CROSS SECTION

NOT TO SCALE

CHECK ON AVAILABILITY OF ALL UNITS w/ LOCAL PRODUCER/ DEALER. SOME UNITS MAY HAVE LIMITED AVAILABILITY.

DISCLAIMER:

These typical details are preliminary and conceptual in nature. They are provided for general information purposes only. Anyone making use of these details and related information does so at their own risk and assumes all liability for such use. Site specific design should be performed by a licensed Professional Engineer based on actual site conditions, materials, and local practices.

Stone Strong LLC retains all common law, statutory, and other reserved rights to these drawings including the copyright. Limited license is granted to copy, reproduce, or modify the details to prepare construction drawings for Stone Strong retaining walls. Stone Strong LLC makes no warranties, either expressed or implied, of merchantability or fitness for any particular purpose, and accepts no responsibility for the accuracy, suitability, or completeness of information contained herein.



www.stonestrong.com

PROJECT

CROSS SECTIONS
STONE STRONG SYSTEMS

DATE: 6/29/18

FILE: 09_6sf.XSec.Grav.28

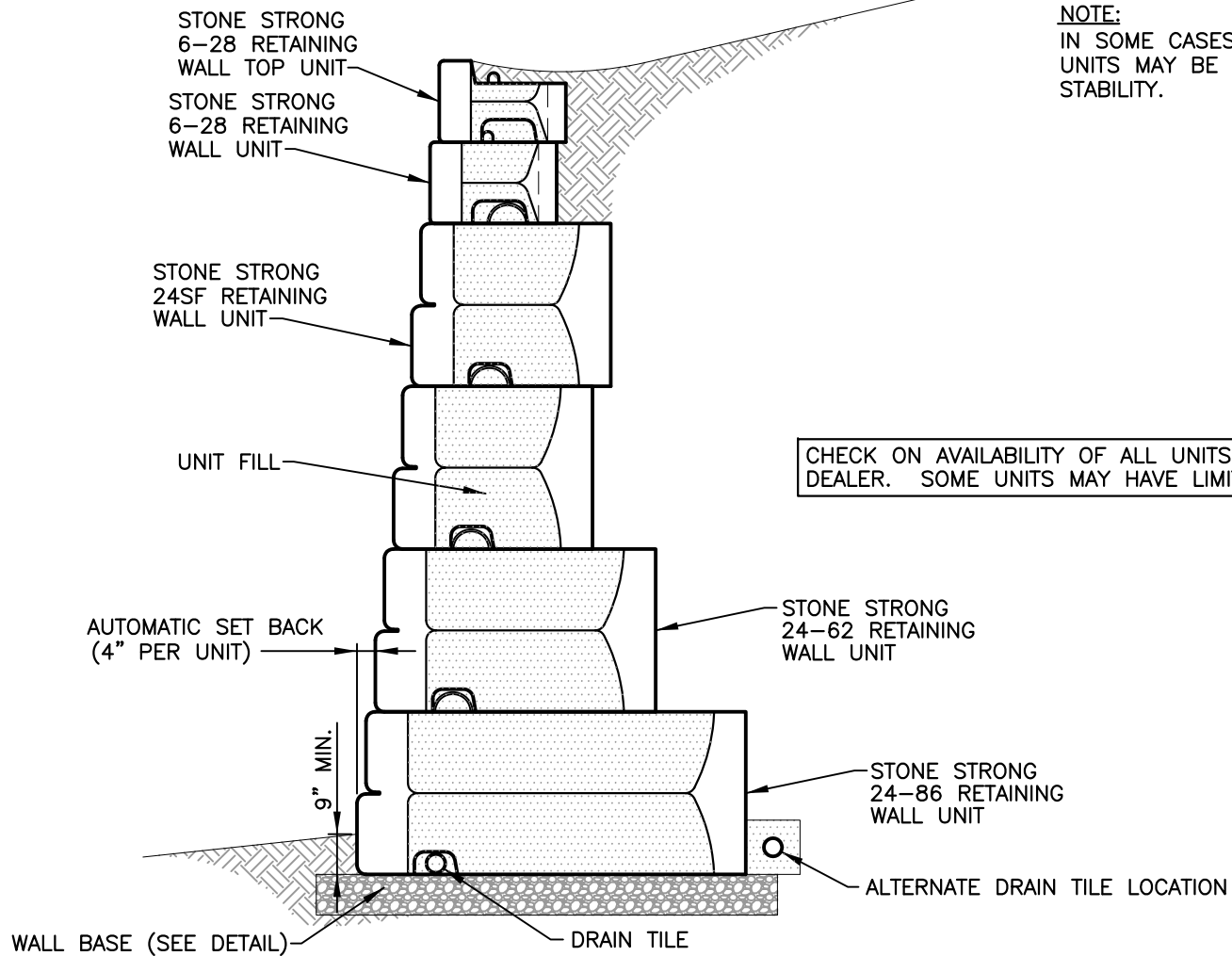

NOTE:
 IN SOME CASES, TWO 24-62 OR 24-86
 UNITS MAY BE REQUIRED FOR INTERNAL
 STABILITY.

CHECK ON AVAILABILITY OF ALL UNITS w/ LOCAL PRODUCER/
 DEALER. SOME UNITS MAY HAVE LIMITED AVAILABILITY.

GRAVITY WALL CROSS SECTION w/EXTENDED BASE UNITS

NOT TO SCALE

DISCLAIMER:

These typical details are preliminary and conceptual in nature. They are provided for general information purposes only. Anyone making use of these details and related information does so at their own risk and assumes all liability for such use. Site specific design should be performed by a licensed Professional Engineer based on actual site conditions, materials, and local practices.

Stone Strong LLC retains all common law, statutory, and other reserved rights to these drawings including the copyright. Limited license is granted to copy, reproduce, or modify the details to prepare construction drawings for Stone Strong retaining walls. Stone Strong LLC makes no warranties, either expressed or implied, of merchantability or fitness for any particular purpose, and accepts no responsibility for the accuracy, suitability, or completeness of information contained herein.

 www.stonestrong.com	PROJECT
	CROSS SECTIONS STONE STRONG SYSTEMS
DATE: 6/29/18	FILE: 10_HD XSec.28

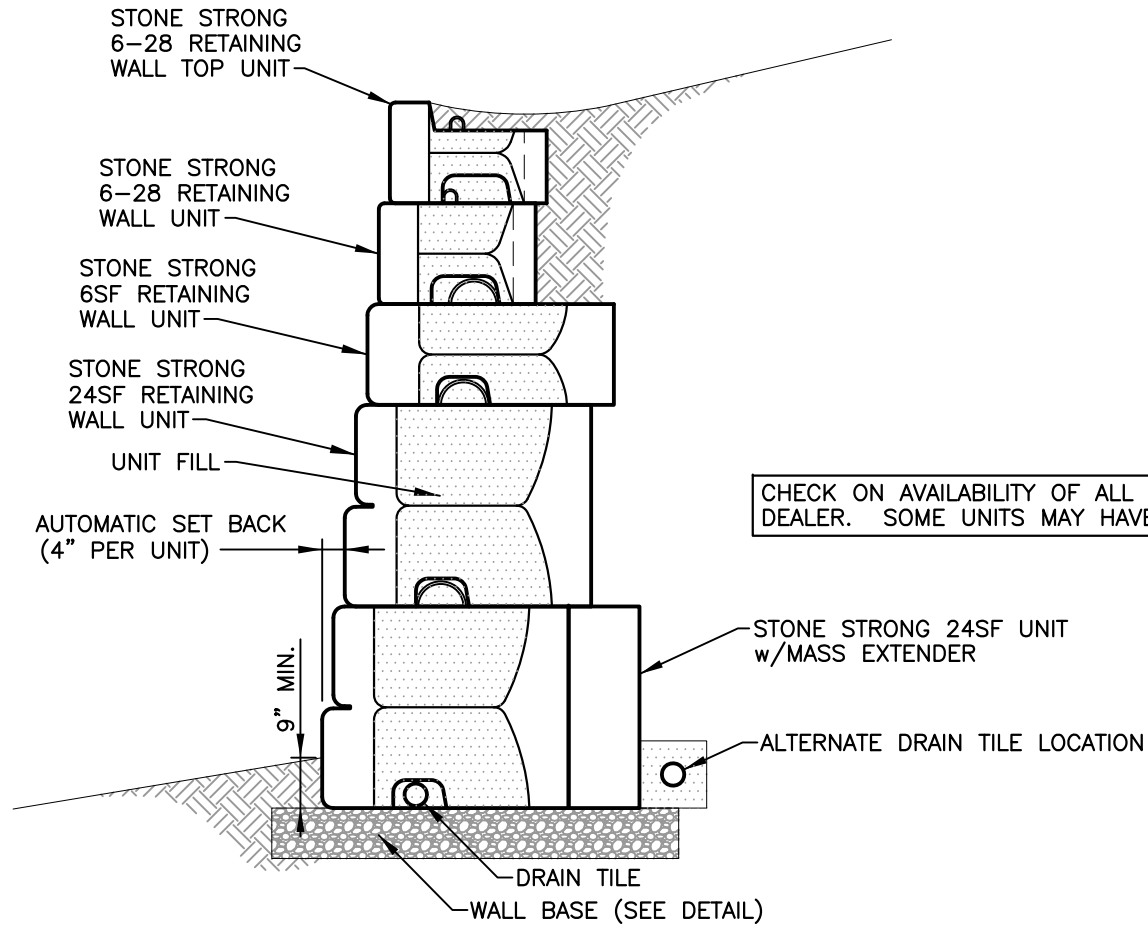

CHECK ON AVAILABILITY OF ALL UNITS w/ LOCAL PRODUCER/ DEALER. SOME UNITS MAY HAVE LIMITED AVAILABILITY.

GRAVITY WALL
CROSS SECTION w/MASS EXTENDER
 NOT TO SCALE

DISCLAIMER:

These typical details are preliminary and conceptual in nature. They are provided for general information purposes only. Anyone making use of these details and related information does so at their own risk and assumes all liability for such use. Site specific design should be performed by a licensed Professional Engineer based on actual site conditions, materials, and local practices.

Stone Strong LLC retains all common law, statutory, and other reserved rights to these drawings including the copyright. Limited license is granted to copy, reproduce, or modify the details to prepare construction drawings for Stone Strong retaining walls. Stone Strong LLC makes no warranties, either expressed or implied, of merchantability or fitness for any particular purpose, and accepts no responsibility for the accuracy, suitability, or completeness of information contained herein.

 www.stonestrong.com	PROJECT
	CROSS SECTIONS STONE STRONG SYSTEMS
DATE: 6/29/18	FILE: 11_24sf.XSec.Mass.28

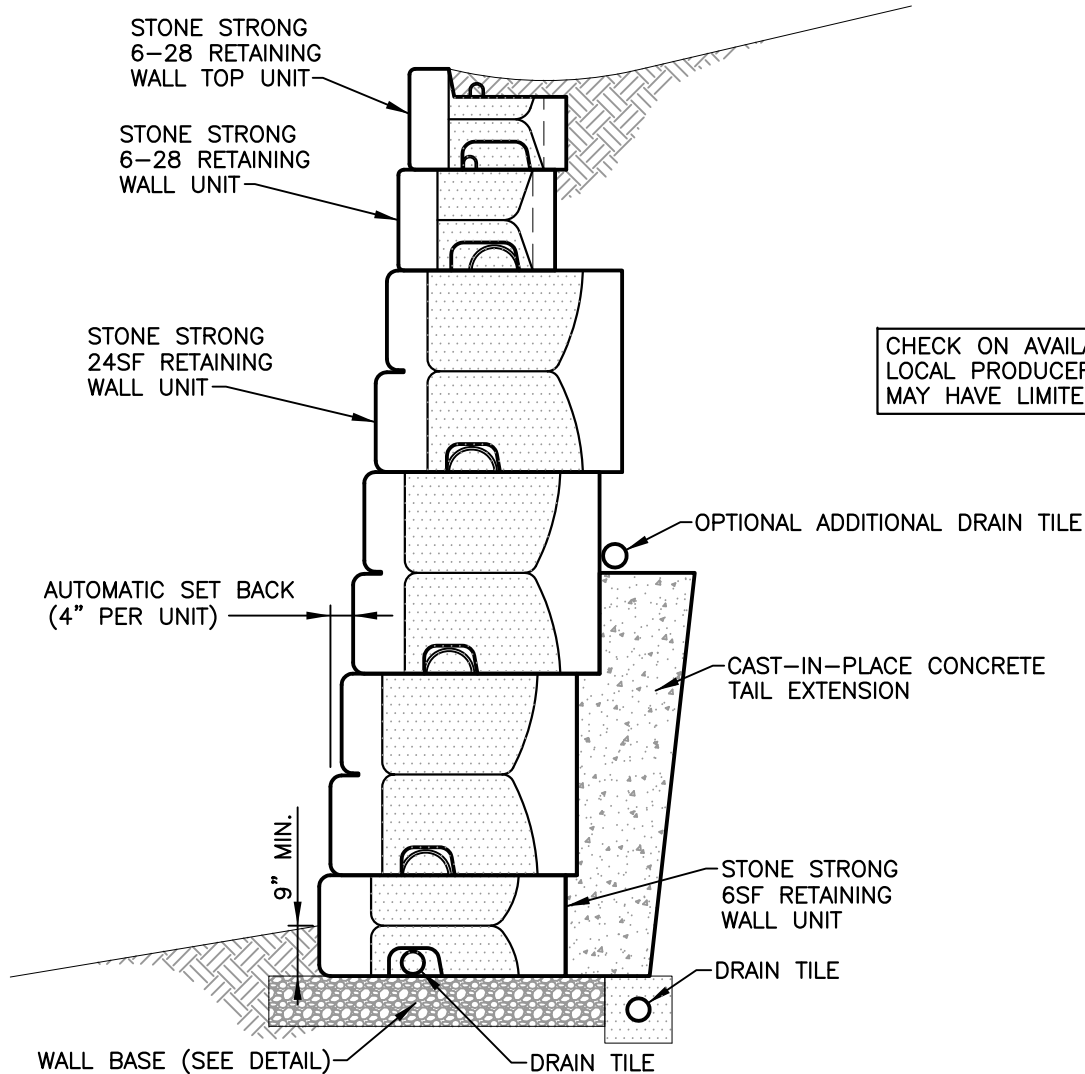

CHECK ON AVAILABILITY OF ALL UNITS w/
LOCAL PRODUCER/DEALER. SOME UNITS
MAY HAVE LIMITED AVAILABILITY.

GRAVITY WALL
CROSS SECTION w/CONCRETE TAIL EXTENSION
NOT TO SCALE

DISCLAIMER:

These typical details are preliminary and conceptual in nature. They are provided for general information purposes only. Anyone making use of these details and related information does so at their own risk and assumes all liability for such use. Site specific design should be performed by a licensed Professional Engineer based on actual site conditions, materials, and local practices.

Stone Strong LLC retains all common law, statutory, and other reserved rights to these drawings including the copyright. Limited license is granted to copy, reproduce, or modify the details to prepare construction drawings for Stone Strong retaining walls. Stone Strong LLC makes no warranties, either expressed or implied, of merchantability or fitness for any particular purpose, and accepts no responsibility for the accuracy, suitability, or completeness of information contained herein.

 www.stonestrong.com	PROJECT
	CROSS SECTIONS STONE STRONG SYSTEMS
DATE: 6/29/18	FILE: 12_24sf.XSec.CIP.28

NOTE:
 VERTICAL UNITS REQUIRE A MODIFIED
 ALIGNMENT RECESS AND A MODIFIED FACE.

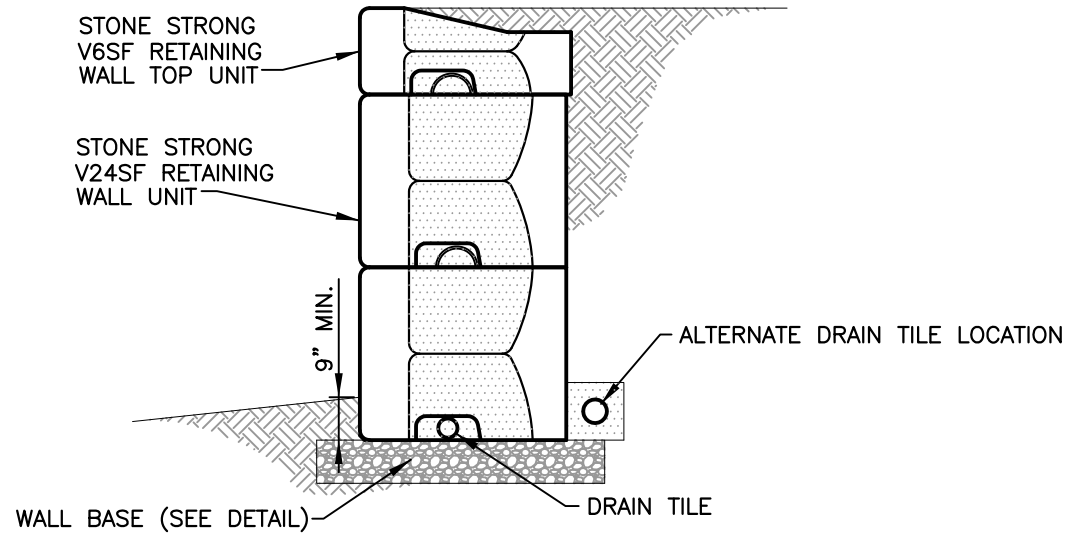

TYPICAL GRAVITY WALL CROSS SECTION

NOT TO SCALE

DISCLAIMER:

These typical details are preliminary and conceptual in nature. They are provided for general information purposes only. Anyone making use of these details and related information does so at their own risk and assumes all liability for such use. Site specific design should be performed by a licensed Professional Engineer based on actual site conditions, materials, and local practices.

Stone Strong LLC retains all common law, statutory, and other reserved rights to these drawings including the copyright. Limited license is granted to copy, reproduce, or modify the details to prepare construction drawings for Stone Strong retaining walls. Stone Strong LLC makes no warranties, either expressed or implied, of merchantability or fitness for any particular purpose, and accepts no responsibility for the accuracy, suitability, or completeness of information contained herein.



www.stonestrong.com

PROJECT

CROSS SECTIONS
 STONE STRONG SYSTEMS

DATE: 6/29/18 | FILE: 13_VertFaceXSec2

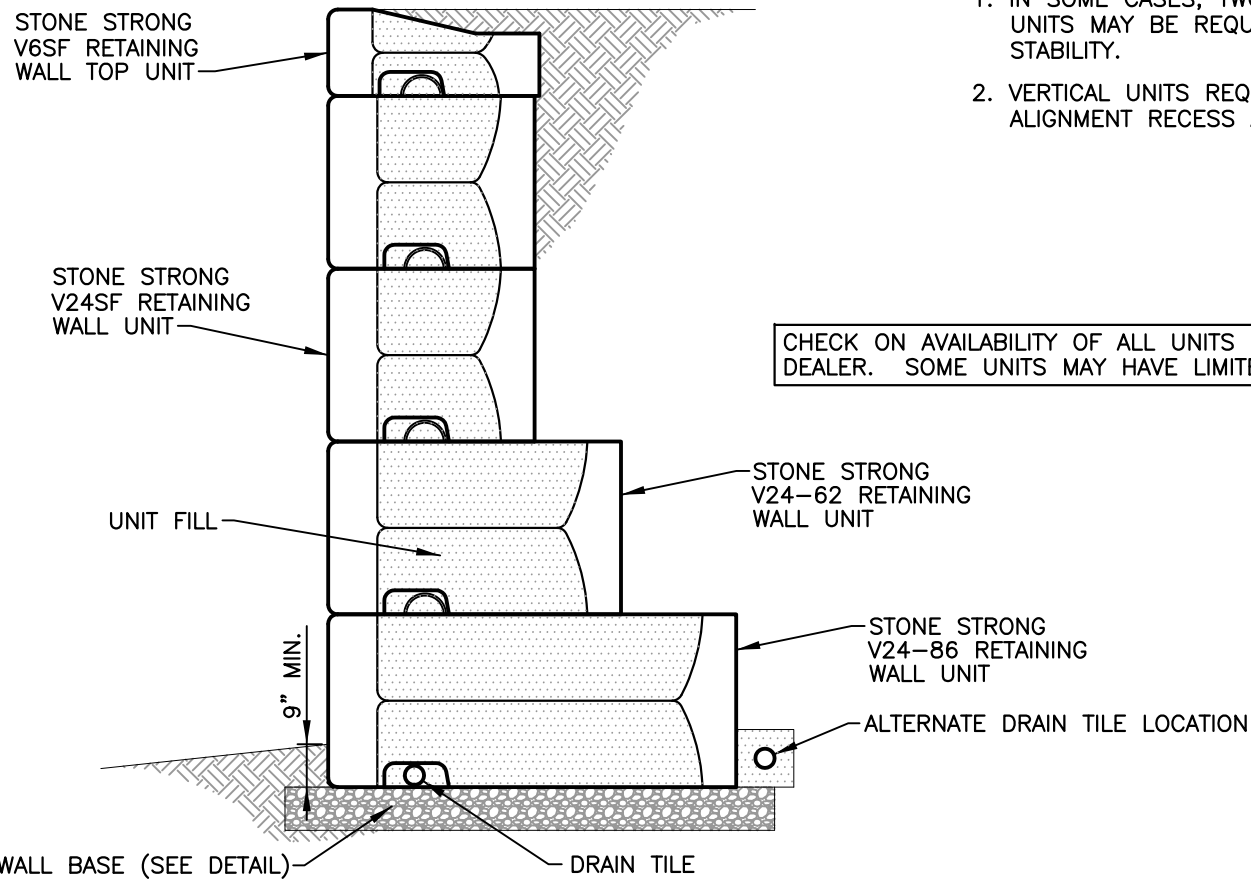

NOTES:

1. IN SOME CASES, TWO 24-62 OR 24-86 UNITS MAY BE REQUIRED FOR INTERNAL STABILITY.
2. VERTICAL UNITS REQUIRE A MODIFIED ALIGNMENT RECESS AND A MODIFIED FACE.

CHECK ON AVAILABILITY OF ALL UNITS w/ LOCAL PRODUCER/ DEALER. SOME UNITS MAY HAVE LIMITED AVAILABILITY.

TYPICAL GRAVITY WALL CROSS SECTION w/HD BASE UNITS

NOT TO SCALE

DISCLAIMER:

These typical details are preliminary and conceptual in nature. They are provided for general information purposes only. Anyone making use of these details and related information does so at their own risk and assumes all liability for such use. Site specific design should be performed by a licensed Professional Engineer based on actual site conditions, materials, and local practices.

Stone Strong LLC retains all common law, statutory, and other reserved rights to these drawings including the copyright. Limited license is granted to copy, reproduce, or modify the details to prepare construction drawings for Stone Strong retaining walls. Stone Strong LLC makes no warranties, either expressed or implied, of merchantability or fitness for any particular purpose, and accepts no responsibility for the accuracy, suitability, or completeness of information contained herein.

 <p>www.stonestrong.com</p>	PROJECT	
	<p>CROSS SECTIONS STONE STRONG SYSTEMS</p>	
DATE: 6/29/18	FILE: 14_VertFaceXSec1	

NOTE:
 VERTICAL UNITS REQUIRE A MODIFIED
 ALIGNMENT RECESS AND A MODIFIED FACE.

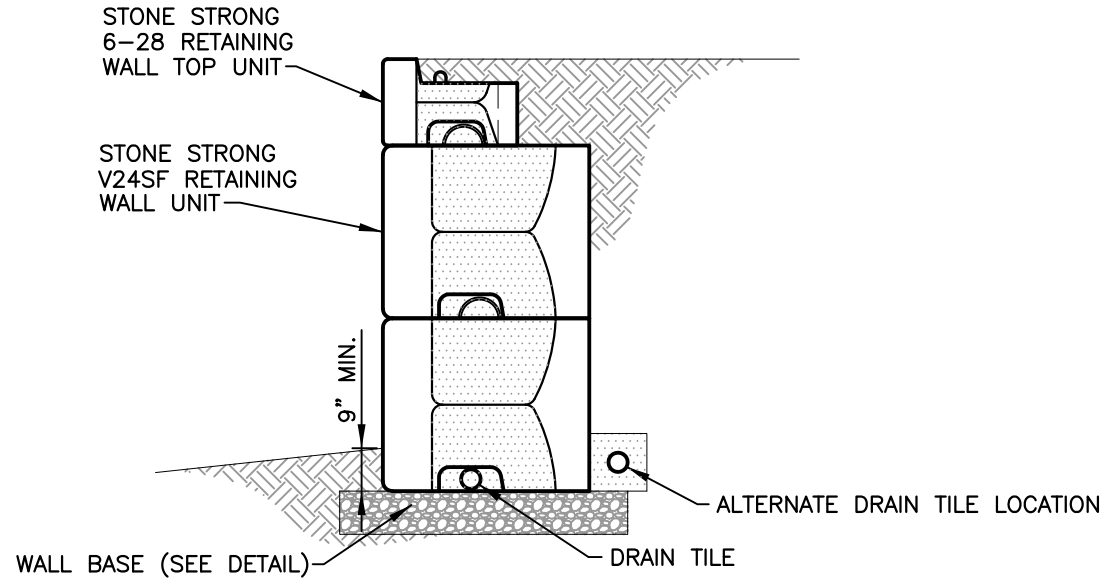

VERTICAL FACE GRAVITY WALL CROSS SECTION

NOT TO SCALE

CHECK ON AVAILABILITY OF ALL UNITS w/ LOCAL PRODUCER/
 DEALER. SOME UNITS MAY HAVE LIMITED AVAILABILITY.

DISCLAIMER:

These typical details are preliminary and conceptual in nature. They are provided for general information purposes only. Anyone making use of these details and related information does so at their own risk and assumes all liability for such use. Site specific design should be performed by a licensed Professional Engineer based on actual site conditions, materials, and local practices.

Stone Strong LLC retains all common law, statutory, and other reserved rights to these drawings including the copyright. Limited license is granted to copy, reproduce, or modify the details to prepare construction drawings for Stone Strong retaining walls. Stone Strong LLC makes no warranties, either expressed or implied, of merchantability or fitness for any particular purpose, and accepts no responsibility for the accuracy, suitability, or completeness of information contained herein.



www.stonestrong.com

PROJECT

CROSS SECTIONS
 STONE STRONG SYSTEMS

DATE: 6/29/18 | FILE: 15_VertFaceXSec2.28

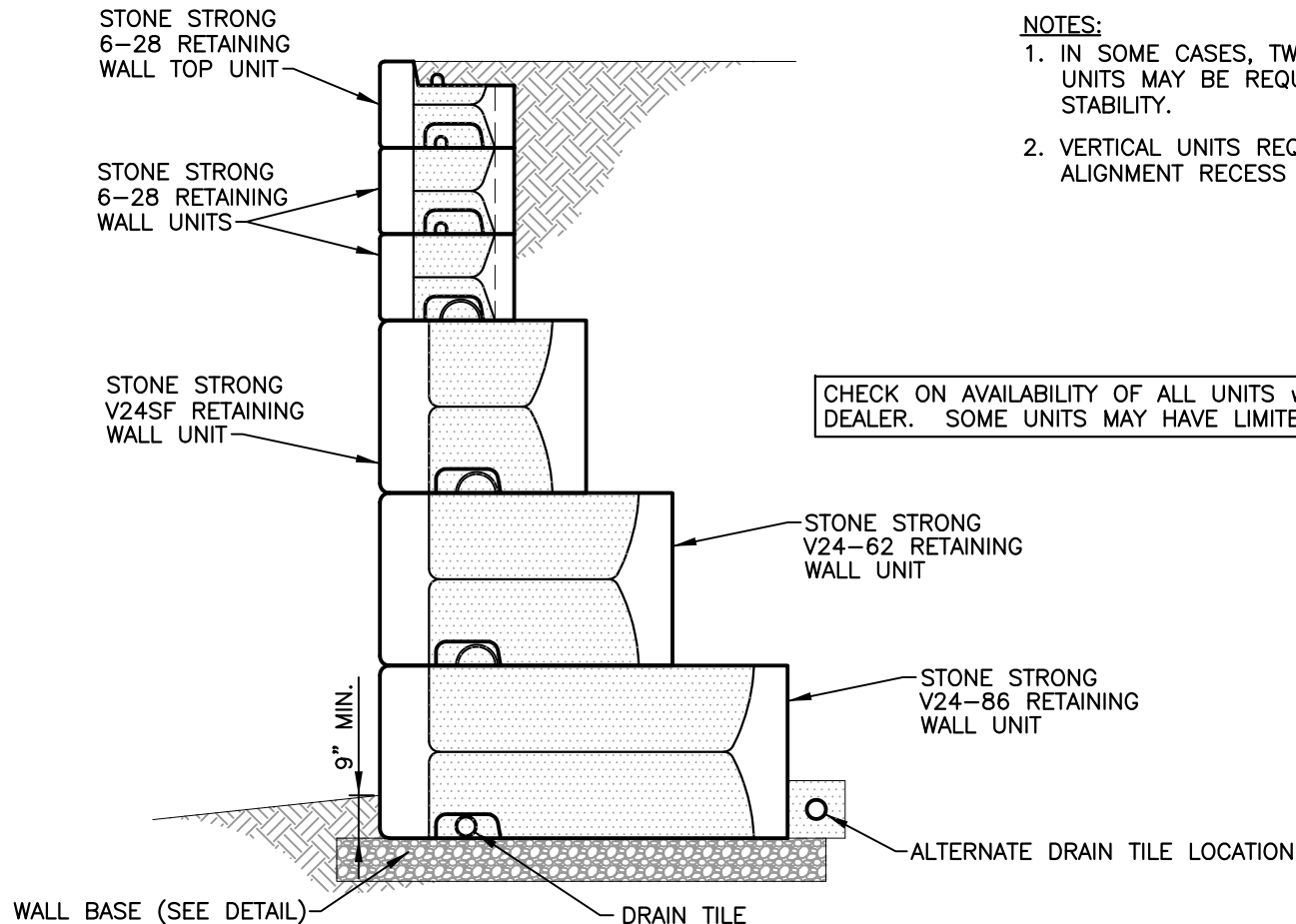

NOTES:

1. IN SOME CASES, TWO 24-62 OR 24-86 UNITS MAY BE REQUIRED FOR INTERNAL STABILITY.
2. VERTICAL UNITS REQUIRE A MODIFIED ALIGNMENT RECESS AND A MODIFIED FACE.

CHECK ON AVAILABILITY OF ALL UNITS w/ LOCAL PRODUCER/ DEALER. SOME UNITS MAY HAVE LIMITED AVAILABILITY.

**VERTICAL FACE GRAVITY WALL
CROSS SECTION w/EXTENDED BASE UNITS**

NOT TO SCALE

DISCLAIMER:

These typical details are preliminary and conceptual in nature. They are provided for general information purposes only. Anyone making use of these details and related information does so at their own risk and assumes all liability for such use. Site specific design should be performed by a licensed Professional Engineer based on actual site conditions, materials, and local practices.

Stone Strong LLC retains all common law, statutory, and other reserved rights to these drawings including the copyright. Limited license is granted to copy, reproduce, or modify the details to prepare construction drawings for Stone Strong retaining walls. Stone Strong LLC makes no warranties, either expressed or implied, of merchantability or fitness for any particular purpose, and accepts no responsibility for the accuracy, suitability, or completeness of information contained herein.



www.stonestrong.com

PROJECT

CROSS SECTIONS
STONE STRONG SYSTEMS

DATE: 6/29/18 | FILE: 16_VertFaceXSec1.28

NOTES:

1. DRAIN TILE MAY BE ELIMINATED AT THE DISCRETION OF THE SITE ENGINEER.
2. DAYLIGHT DRAIN TILE AT LOW POINTS THROUGH WALL FACE OR AT ENDS; MAXIMUM SPACING 100 FEET OR PER SITE CONDITIONS.

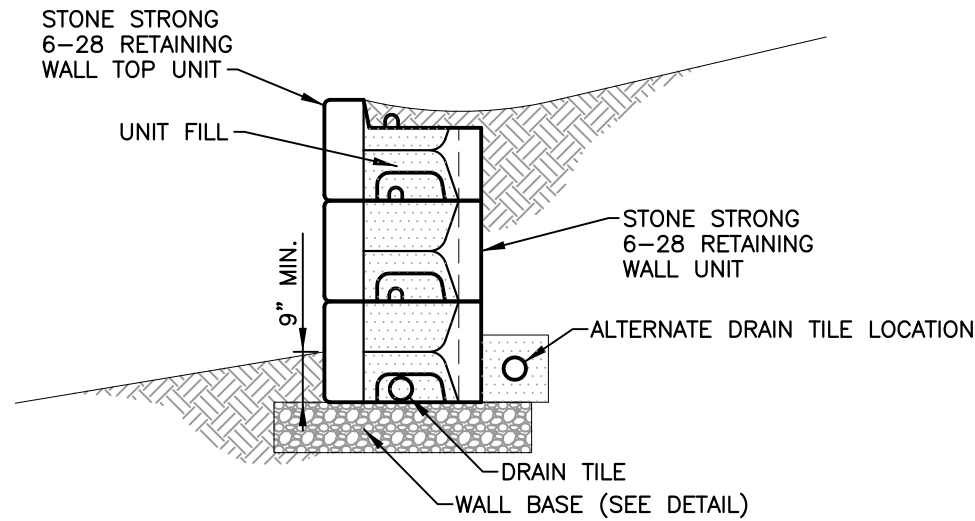

VERTICAL FACE
6-28 GRAVITY WALL CROSS SECTION
NOT TO SCALE

CHECK ON AVAILABILITY OF ALL UNITS w/ LOCAL PRODUCER/ DEALER. SOME UNITS MAY HAVE LIMITED AVAILABILITY.

DISCLAIMER:

These typical details are preliminary and conceptual in nature. They are provided for general information purposes only. Anyone making use of these details and related information does so at their own risk and assumes all liability for such use. Site specific design should be performed by a licensed Professional Engineer based on actual site conditions, materials, and local practices.

Stone Strong LLC retains all common law, statutory, and other reserved rights to these drawings including the copyright. Limited license is granted to copy, reproduce, or modify the details to prepare construction drawings for Stone Strong retaining walls. Stone Strong LLC makes no warranties, either expressed or implied, of merchantability or fitness for any particular purpose, and accepts no responsibility for the accuracy, suitability, or completeness of information contained herein.



www.stonestrong.com

PROJECT

CROSS SECTIONS
STONE STRONG SYSTEMS

DATE: 6/29/18

FILE: 17_6-28.XSec.Grav.Vert

NOTES:

1. SEE TECH MEMO TM-2018-01 FOR BLOCK REINFORCEMENT REQUIREMENTS.
2. HEAVY DUTY UNIT REINFORCEMENT SHOULD BE USED FOR LOWER SECTIONS OF PARAWEB MSE WALLS AS FOLLOWS:
 FOR 24SF UNITS: BELOW 36 FEET FROM THE TOP OF THE WALL
 FOR 6SF AND 6-28 UNITS: BELOW 12 FEET FROM THE TOP OF THE WALL

BACKFILL REQUIREMENTS:

1. PARTICLE SIZE MUST BE LESS THAN 6".
2. pH RANGE BETWEEN 4 AND 11.
3. FINES MUST BE <20%.

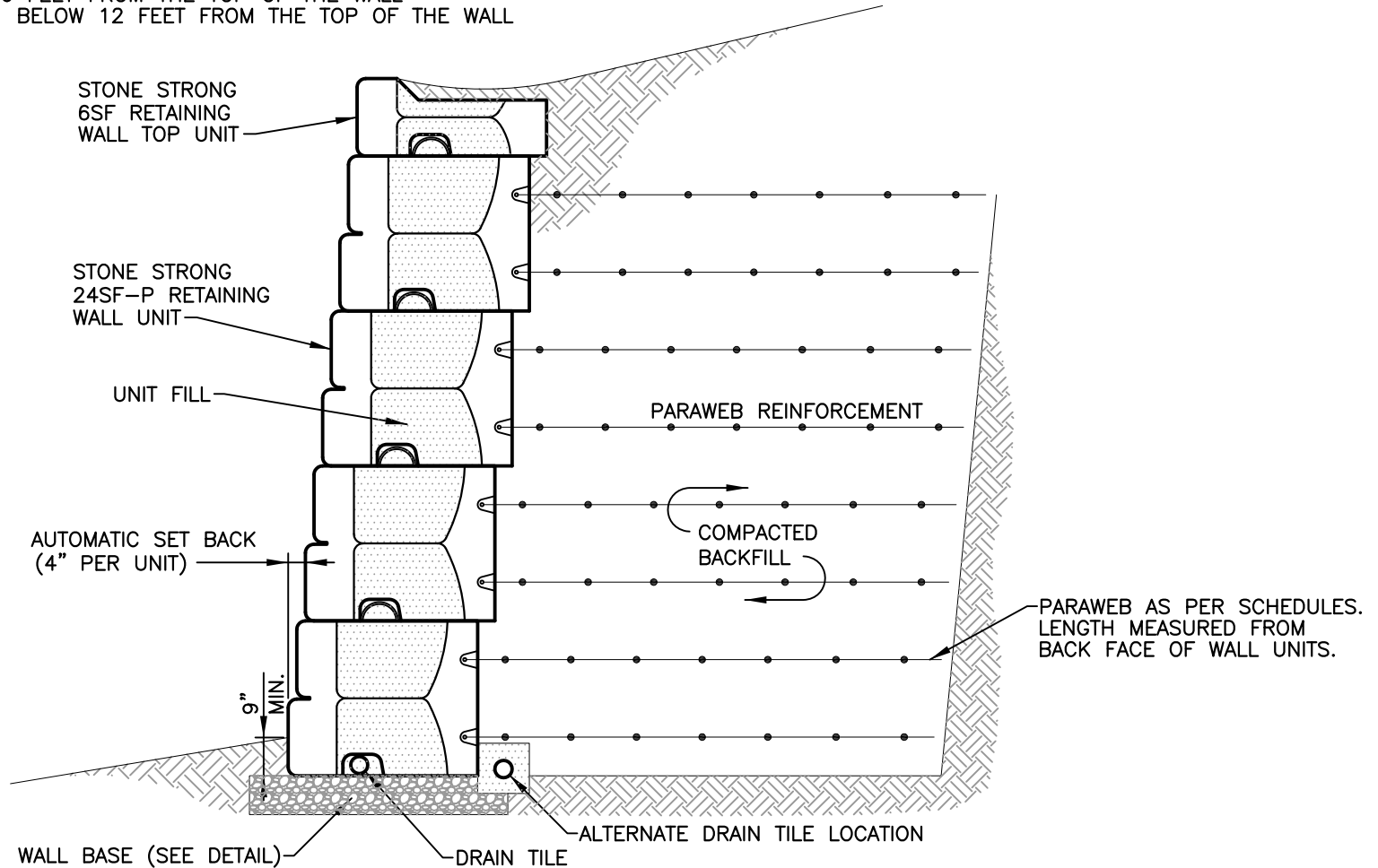

PARAWEB REINFORCED WALL CROSS SECTION
 NOT TO SCALE

DISCLAIMER:

These typical details are preliminary and conceptual in nature. They are provided for general information purposes only. Anyone making use of these details and related information does so at their own risk and assumes all liability for such use. Site specific design should be performed by a licensed Professional Engineer based on actual site conditions, materials, and local practices.

Stone Strong LLC retains all common law, statutory, and other reserved rights to these drawings including the copyright. Limited license is granted to copy, reproduce, or modify the details to prepare construction drawings for Stone Strong retaining walls. Stone Strong LLC makes no warranties, either expressed or implied, of merchantability or fitness for any particular purpose, and accepts no responsibility for the accuracy, suitability, or completeness of information contained herein.

 www.stonestrong.com	PROJECT
	CROSS SECTIONS STONE STRONG SYSTEMS
DATE: 6/29/18	FILE: 18_24sf-XSec-BattPara

NOTES:

- 1. SEE TECH MEMO TM-2018-01 FOR BLOCK REINFORCEMENT REQUIREMENTS.
- 2. HEAVY DUTY UNIT REINFORCEMENT SHOULD BE USED FOR LOWER SECTIONS OF PARAWEB MSE WALLS AS FOLLOWS:
 - FOR 24SF UNITS: BELOW 36 FEET FROM THE TOP OF THE WALL
 - FOR 6SF AND 6-28 UNITS: BELOW 12 FEET FROM THE TOP OF THE WALL

BACKFILL REQUIREMENTS:

- 1. PARTICLE SIZE MUST BE LESS THAN 6".
- 2. pH RANGE BETWEEN 4 AND 11.
- 3. FINES MUST BE <20%.

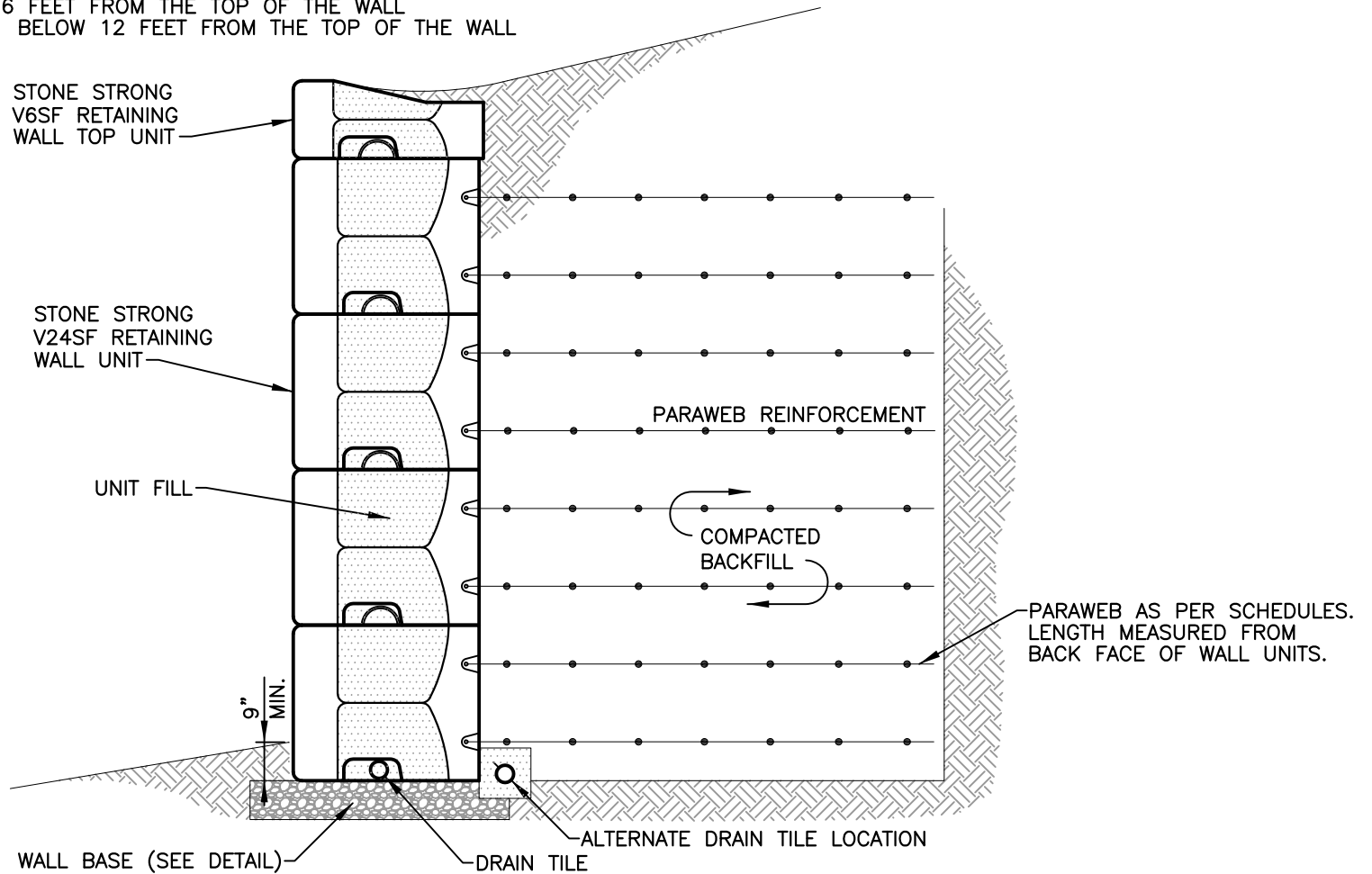

PARAWEB REINFORCED WALL CROSS SECTION

NOT TO SCALE

DISCLAIMER:

These typical details are preliminary and conceptual in nature. They are provided for general information purposes only. Anyone making use of these details and related information does so at their own risk and assumes all liability for such use. Site specific design should be performed by a licensed Professional Engineer based on actual site conditions, materials, and local practices.

Stone Strong LLC retains all common law, statutory, and other reserved rights to these drawings including the copyright. Limited license is granted to copy, reproduce, or modify the details to prepare construction drawings for Stone Strong retaining walls. Stone Strong LLC makes no warranties, either expressed or implied, of merchantability or fitness for any particular purpose, and accepts no responsibility for the accuracy, suitability, or completeness of information contained herein.



www.stonestrong.com

PROJECT

CROSS SECTIONS
STONE STRONG SYSTEMS

DATE: 6/29/18

FILE: 19_24sf-XSec-VertPara

NOTE:

24SF UNITS MUST BE REINFORCED BELOW THE TOP
12 FEET IN GEOGRID REINFORCED WALLS.

GEOGRID REINFORCEMENT NOT RECOMMENDED FOR
WALLS OVER 24 FEET TALL.

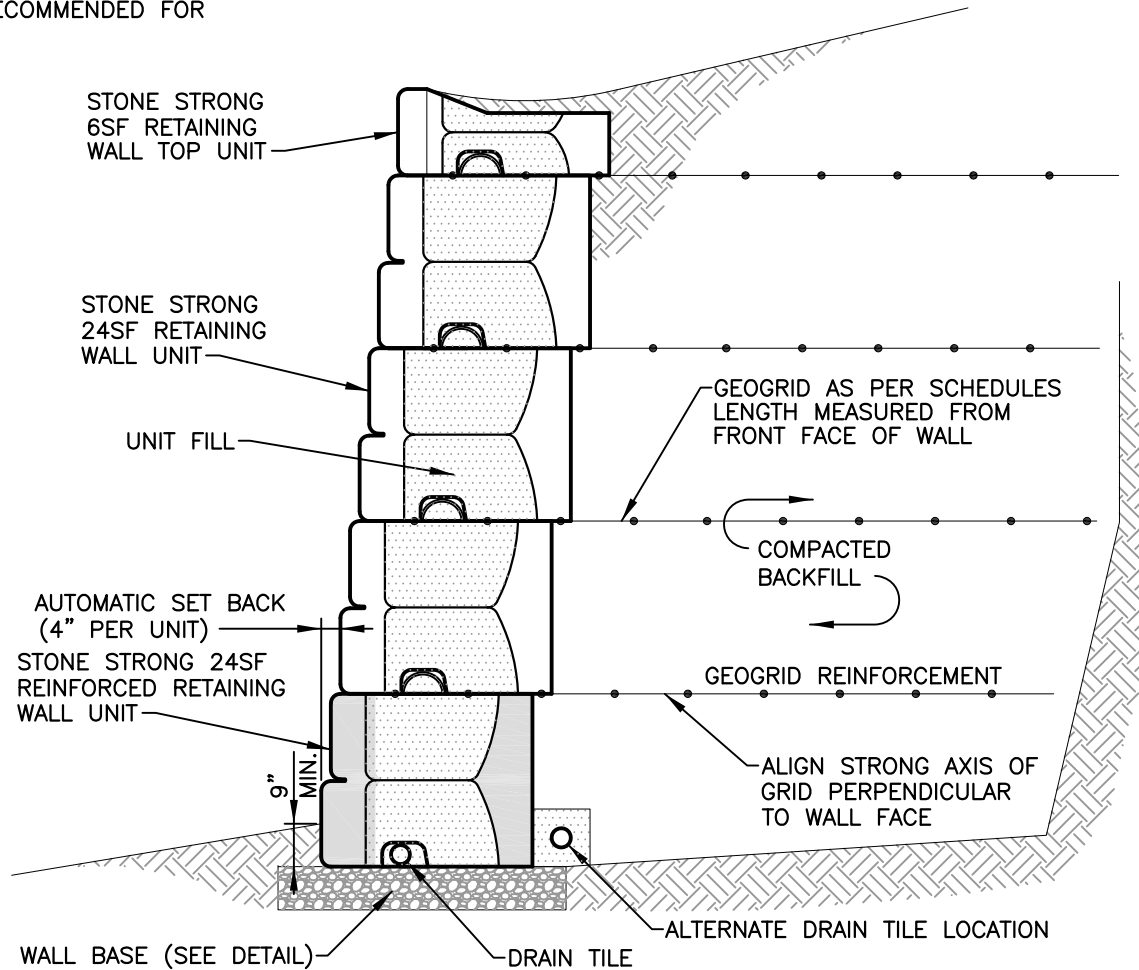

REINFORCED WALL CROSS SECTION

NOT TO SCALE

DISCLAIMER:

These typical details are preliminary and conceptual in nature. They are provided for general information purposes only. Anyone making use of these details and related information does so at their own risk and assumes all liability for such use. Site specific design should be performed by a licensed Professional Engineer based on actual site conditions, materials, and local practices.

Stone Strong LLC retains all common law, statutory, and other reserved rights to these drawings including the copyright. Limited license is granted to copy, reproduce, or modify the details to prepare construction drawings for Stone Strong retaining walls. Stone Strong LLC makes no warranties, either expressed or implied, of merchantability or fitness for any particular purpose, and accepts no responsibility for the accuracy, suitability, or completeness of information contained herein.

 www.stonestrong.com	PROJECT
	CROSS SECTIONS STONE STRONG SYSTEMS
DATE: 6/29/18	FILE: 20_24sf.XSec.Reinf

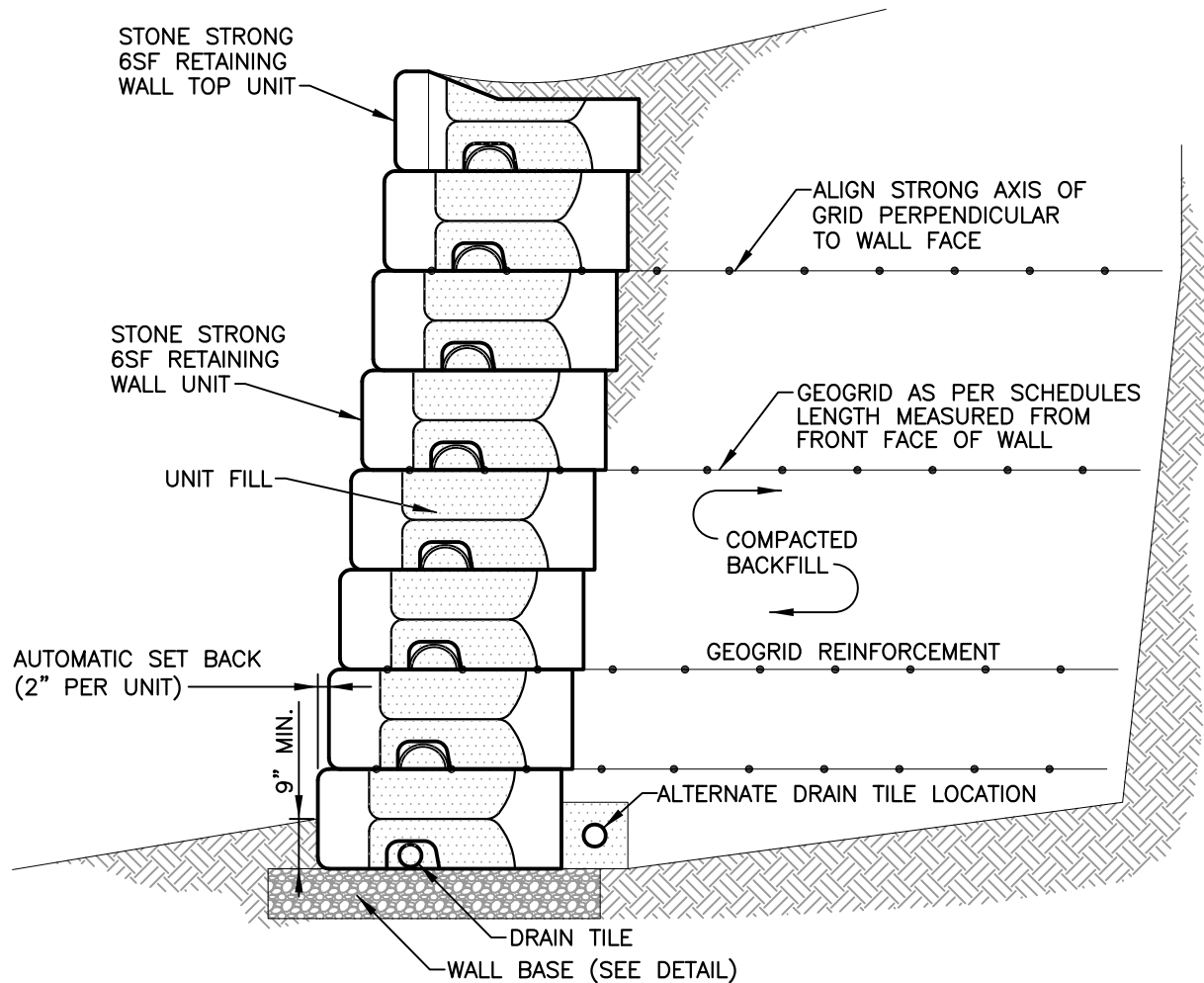

6SF REINFORCED WALL CROSS SECTION

NOT TO SCALE

DISCLAIMER:

These typical details are preliminary and conceptual in nature. They are provided for general information purposes only. Anyone making use of these details and related information does so at their own risk and assumes all liability for such use. Site specific design should be performed by a licensed Professional Engineer based on actual site conditions, materials, and local practices.

Stone Strong LLC retains all common law, statutory, and other reserved rights to these drawings including the copyright. Limited license is granted to copy, reproduce, or modify the details to prepare construction drawings for Stone Strong retaining walls. Stone Strong LLC makes no warranties, either expressed or implied, of merchantability or fitness for any particular purpose, and accepts no responsibility for the accuracy, suitability, or completeness of information contained herein.



www.stonestrong.com

PROJECT

CROSS SECTIONS
STONE STRONG SYSTEMS

DATE: 6/29/18

FILE: 21_6sf.XSec.Reinf